

RUCKUS® ICX switch family

Scalable fixed form factor switches for next-generation IP networks

The RUCKUS ICX fixed form-factor switch series works together to deliver a simple secure and scalable high-performance network solution supporting today's most demanding networking needs.

In today's "mobile-first" world, the campus network has taken on a new role as a critical underlay for wireless traffic. Support for wireless networking is at the core of the ICX family design. ICX switches' high PoE budgets and support for PoE+ and PoH will power the new generations of wireless APs, surveillance cameras, video displays and other devices for years to come. All ICX switches offer 10 GbE uplinks options at the entry level and 40 GbE and 100 GbE at the mid-range to eliminate bottlenecks between network layers and ensure a smooth user experience in high-density wireless environments.



Benefits

Upgradable, flexible architecture

- Multi-purpose switches can be deployed standalone, stacked or in a campus fabric
- Upgradable uplink/stacking ports from 1 GbE to 10 GbE and 40 GbE to 100 GbE

Industry leading price/performance

- Industry-leading access switches offering unprecedented capabilities
- High-performance stackable aggregation and core switches deliver more for less

Scale-out fabric-based architecture reduces cost of operations

- RUCKUS campus fabric technology is supported on all ICX 7000 models*
- Delivers the benefits of a chassis with the flexibility of stackable switches

Unique stacking capabilities simplify management

- Stack over long distances using standard Ethernet optics
- Superior scalability up to 12 switches per stack
- Aggregation and core ICX switches also support stacking for unmatched scalability

Multigigabit Ethernet enables next-generation wireless deployment

- IEEE 802.3bz standard-based multigigabit Ethernet support
- Optimizes next-generation 802.11ac Wave 2 and future wireless AP deployment, increasing performance while reducing cost

* Campus fabric on ICX 7850 supported in a future software release.

ICX multi-purpose switches can be deployed standalone, stacked or within a campus fabric. Together they comprise the building blocks for simplified network deployment and management, scale-out networking, and investment protection with the industry's lowest total cost of ownership. The ICX switches can be deployed in homogeneous stacks using local or long-distance links of up to 10 kilometers for maximum flexibility. When configured to work with innovative RUCKUS campus fabric technology, customers can mix and match ICX switches to build highly converged networks that simplify deployment and management and improve operational efficiency.

ICX switches take stacking to the next level

RUCKUS ICX fixed form factor switches go beyond traditional stacking to offer capabilities that take flexibility, ease of management and cost effectiveness to the next level.

- **Stacking on standard Ethernet ports:** Unlike traditional stackable switches, ICX switches do not rely on proprietary stacking ports and stacking cables. Stacking is supported over standard 10 Gbps SFP+ or 40 Gbps QSFP+ or 100 Gbps QSFP28 ports. The same ports can be configured for stacking or to forward uplink traffic over standard Ethernet. This provides a level of flexibility unavailable on other stackable switches. Additionally, multiple stacking ports can be aggregated to increase the stacking bandwidth and boost performance when needed.
- **Long-distance stacking across wiring closets:** In addition to standard short SFP+ to SFP+ and QSFP+ to QSFP+ copper stacking cables, ICX switches can also use standard SFP+ and QSFP+ optical transceivers and fiber for stacking with distance up to 10 km between switches. This enables long-distance stacking between wiring closets within a building or even between buildings.
- **No hardware module required for stacking:** Many traditional stackable switches require the purchase of additional hardware stacking modules to be able to stack. All RUCKUS ICX 7000 series switches come with the hardware necessary for stacking thanks to the use of standard stacking ports.*
- **In-Service Software Upgrade (ISSU):** ICX stacking technology supports ISSU across stacked switches, a unique capability that enables a stack of ICX switches to go through a software upgrade without taking down the stack. Stack members are upgraded sequentially one after the other while the other members are in service. The process is completely automated for the network administrator.

* Stacking not supported on the ICX 7150 eight-port models.

- **Superior scalability with up to 12 switches per stack:** Most network vendors limit the maximum number of switches per stack to eight units or less. ICX switching technology supports up to 12 switches per stack, offering 50 percent more ports per stack than traditional stackable switches.
- **Stacking at the aggregation and core:** Thanks to ICX switches' advanced stacking technology, CommScope is the only vendor to offer a stack-based solution for the campus aggregation/core. The ICX 7850 switch is a 1U high-performance, high-availability, and market-leading-density 40/100 GbE solution. With industry-leading price/performance and low-latency, cut-through, non-blocking architecture, the RUCKUS ICX 7850 provides unprecedented stacking density and performance with up to 12 switches per stack and up to 9.6 Tbps of aggregated stacking bandwidth, limiting inter-switch bottlenecks and offering cost-effective large-scale chassis replacement at the campus aggregation/core. Additionally, support for ISSU at the stack level enables the ICX 7850 to deliver chassis-level high availability and reliability to maximize network uptime.



Figure 1: RUCKUS ICX switches can be stacked together using standard SFP+ or QSFP+ ports and optics to create a single logical device over distances up to 10 km.

Enterprise-class availability

RUCKUS stacking technology delivers high availability, performing real-time state synchronization across the stack and enabling instantaneous hitless failover to a standby controller in the unlikely event of a failure of the master stack controller. Users can use hot insertion/removal of stack members to avoid interrupting service when adding a switch to increase the capacity of a stack or replacing a switch that needs servicing.

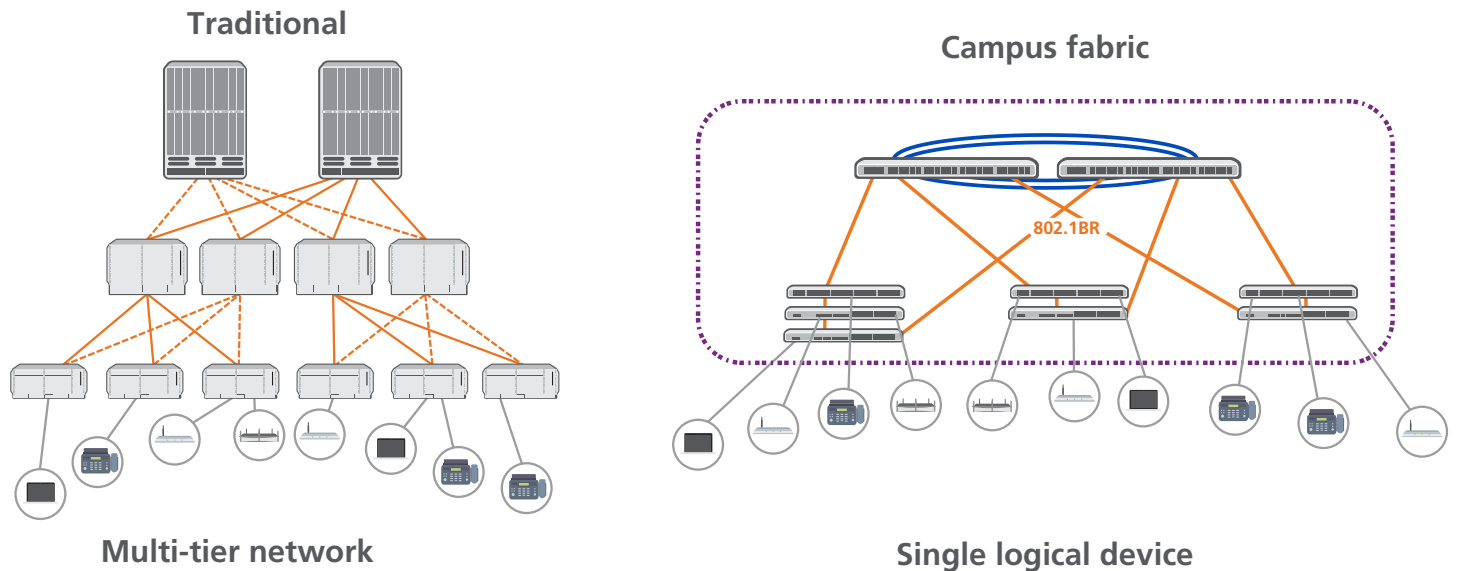

Figure 2: The RUCKUS campus fabric architecture versus a traditional multi-tier campus network.

In addition to stack-level high availability, RUCKUS ICX switches include system-level high-availability features, such as dual hot-swappable, load-sharing, and redundant power supplies. The modular design also has dual hot-swappable fan trays. These features provide another level of availability for the campus wiring closet, all in a compact form factor.

The RUCKUS ICX 7000 switches support stack-level In-Service Software Upgrade (ISSU), a unique capability that enables a stack of RUCKUS ICX switches to go through a software upgrade without service interruption, enabling continuous operation during system upgrades.

RUCKUS campus fabric technology

RUCKUS campus fabric technology brings campus networks into the modern era to better support seamless wireless mobility, security, and ease of application deployment. It collapses multiple network layers into a single logical switch, flattening the network and eliminating deployment complexity while simplifying network management and reducing operating costs.

All of the RUCKUS ICX 7000 platforms can leverage RUCKUS campus fabric to extend network options and scalability. The technology integrates aggregation switches like the RUCKUS ICX 7750 and ICX 7650 with access switches like the RUCKUS ICX

7450, ICX 7250, and ICX 7150, by collapsing network layers into a single-logical switch. This logical device results in sharing network services while reducing management touch points and network hops through a single layer design spanning the entire campus network. New switches are quickly and easily added—simply connect them to a fabric port and the switch is automatically configured and added to the campus fabric. The fabric controller also performs automated software image upgrade for all fabric switch members when a new software release is available for a given switch model.

RUCKUS campus fabric combines the power of Distributed Chassis design with the flexibility and cost-effectiveness of fixed form factor switch building blocks. The traditional aggregation/core layer is replaced by a stack of high-performance ICX 7750 or ICX 7650 switches which deliver a unified network control plane that acts as the central management and traffic forwarding authority for the entire campus fabric domain. The high-performance ICX access switches act as virtual line-cards for the entire fabric. Connections between two devices in the fabric can be up to 10 km ensuring maximum flexibility and scalability. RUCKUS campus fabric deployments deliver equivalent or better functionality than large, rigid modular chassis systems with significantly lower costs and smaller carbon footprints.

Multigigabit Ethernet technology for next-generation wireless APs

Support for wireless networking is at the core of the ICX family design. The RUCKUS ICX 7150-48ZP, the ICX 7650-48ZP and the ICX 7150-C10ZP compact switch, also called the RUCKUS Z-series switches, are designed to handle next-generation 802.11ac Wave 2 and 802.11ax access points and future wireless technology. These ICX switches support the 803.2bz standard and offer 2.5 GbE ports or 2.5/5/10 GbE ports (on the ICX 7650 and 7150-C10ZP) to connect multigigabit APs at increased data speeds. This new technology delivers up to 10 times the bandwidth of regular Gigabit Ethernet on standard twisted-pair cables, reducing the total number for links needed between switches and APs and optimizing wireless performance and scalability.

More than enough power for network devices

RUCKUS ICX access switches with PoE support offer standard PoE (802.3af; 15 watts), and PoE+ (802.3at; 30 watts) sufficient to drive wireless access points, VoIP phones, video cameras, lighting and other devices. Each ICX switch series offers sufficient power for even the most densely populated environments, with PoE to all ports simultaneously with a single power supply, and drive PoE+ (30 watts) to all ports with dual power supplies.

Additionally, the RUCKUS ICX 7150-48ZP and all ICX 7450 and ICX 7650 switches take PoE to the next level with support for PoH (power-over-HDBaseT) and the 802.3bt standard delivering up to 90 watts per port to power high-end Ethernet devices such as access points, large video displays, surveillance cameras and other devices. These switches are also compatible with UPOE (up to 60 watts per port).

Supporting the most stringent security standards

RUCKUS ICX switches support the latest security standards and encryption technologies. ICX switches are broadly deployed within the U.S. federal government and are therefore required by law to comply with the most stringent security standards. ICX switches are compliant with the following federal certifications: FIPS, Common Criteria, CSFC, and JITC. Each new release of the switch software is recertified by the relevant certification authorities on an ongoing basis.

Ensuring end-to-end data privacy

As organizations move to a hybrid cloud architecture with geographically dispersed business partners, concerns about security breaches are increasing. Many organizations seek to better meet compliance and protect their data in transit—whether across the internet or the enterprise network. CommScope offers a unique stackable switching solution that delivers encryption from the wiring closet, providing a cost-effective way to ensure data security and integrity across both internal and external links without the need to purchase dedicated encryption products.

The RUCKUS 7450 Service Module provides hardware-based acceleration for IPsec VPNs using Advanced Encryption Standards (AES). The RUCKUS 7450 Service Module accelerates IPsec traffic performance by offloading the mathematically intensive part of the process while relying on the switch processor to identify traffic for encryption, negotiate the security associations, and forward encrypted traffic. With 10 Gbps throughput per service module, a single RUCKUS ICX 7450 switch or stack can ensure that service levels are not impacted as compliance requirements and security needs increase.

The ICX 7450 also supports redundant service modules on a stack basis, ensuring that, in the unlikely event of a service module failure, encryption could continue without interruption using another service module on the same switch or the same stack.

Wired/wireless on-boarding and security

RUCKUS Cloudpath Enrollment System (ES) security and policy management platform is supported across the RUCKUS ICX switch family. It enables IT to easily and definitively secure the network, secure users and secure wired and wireless devices. Cloudpath software consolidates and simplifies the deployment of multiple services that are typically disparate and complex to manage: certificate management, policy management and device enablement.

SDN-enabled programmatic control of the network

Software-defined networking (SDN) is a powerful new network paradigm designed for the world's most demanding networking environments that promises breakthrough levels of customization, security, and efficiency. The RUCKUS ICX switches enable SDN by supporting the OpenFlow 1.3 protocol, which facilitates communication between a standard SDN controller and the underlying network infrastructure.

With hybrid-port mode support on the RUCKUS ICX switches, organizations can run traditional protocols and OpenFlow-directed flows at the same time. With an SDN controller and OpenFlow on the RUCKUS ICX switches, IT organizations can receive the benefits of programmatic control while gradually introducing parts of their network into the controller domain without disruption.

Open-standards-based management, monitoring and authentication

RUCKUS ICX switches provide simplified, standards-based management capabilities that help users reduce administrative time and effort while securing their networks.

sFlow-based network monitoring

sFlow is a modern, standards-based network data export protocol (RFC 3176) that addresses many of the challenges network managers face today. By embedding sFlow hardware support into RUCKUS ICX switches, users dramatically reduce implementation costs compared to traditional network monitoring solutions that rely on mirrored ports, probes, and line-tap technologies. Moreover, sFlow gives users full, enterprise-wide monitoring capability for every port in the network.

Automated deployment with auto-provisioning

RUCKUS ICX switches support auto-configuration to simplify deployment and deliver a plug-and-play experience. Users can use this feature to automate IP address and feature configuration of the ICX switches without requiring a highly trained network engineer onsite. When the switches power up, they automatically receive an IP address and configuration from DHCP and Trivial File Transport Protocol (TFTP) servers. Subsequently, the switches automatically receive a software update to be at the same code version as currently installed switches to maintain consistency across the network.

All RUCKUS ICX 7000 series switches can also be auto-provisioned from USB storage. Provisioning a switch can be as simple as plugging in a USB key containing the proper software image and configuration files and re-booting the switch. This greatly simplifies the deployment or unit replacement of switches by untrained personnel.

Ansible support for easy, standard-based network automation

Ansible is a widely used open-source tool that enables simple, agentless IT automation that anyone can use to turn arduous tasks into repeatable playbooks. With Ansible support, ICX switches

can be included in an organization's overall automation strategy for a holistic approach to end-to-end application workload management. ICX switches have been tested with Ansible, and CommScope has created specific Ansible playbooks to facilitate ICX automation.

Open-standards management and authentication

RUCKUS ICX switches include an industry-standard Command Line Interface (CLI) and support Secure Shell (SSHv2), Secure Copy (SCP), and SNMPv3 to restrict and encrypt management communications to the system. Support for Terminal Access Controller Access Control System (TACACS/TACACS+) and RADIUS authentication helps ensure secure operator access.

RUCKUS ICX switches also support HTTP/HTTPS-based web access for configuration via an intuitive graphical interface.

Silent operation

The RUCKUS ICX 7150 can operate silently through either a fanless design or a "silent mode" configuration option depending on the model. The silent mode capability enables the PoE switches to operate with the fan disabled while providing a PoE budget of up to 150 watts for the 24-port model and the 48-port model.

This RUCKUS-exclusive feature enables users to deploy the RUCKUS ICX 7150 switches outside of the wiring closet without disrupting the environment. This capability is critical for certain verticals such as hospitality, education, healthcare, and retail where networking equipment needs to be deployed into a work environment or living space such as a classroom, hotel room, patient room, operating room, or retail space with minimal disruption.

Silent operation allows a common switch platform to be deployed in all environments, eliminating the need to purchase specific fanless models, thus reducing spares holdings and increasing the solution flexibility.

A complete line of switches for campus access, aggregation, and core deployment

RUCKUS ICX 7000 switches support RUCKUS campus fabric technology and are designed to work together to deliver consolidated network management and services sharing between premium and entry-level switches—reducing both complexity and costs while protecting capital investments.

Converged management and control of wired and wireless enterprise networks

Managing enterprise networks continues to become more complex due to the growth in services delivered by wired and wireless networks.

CommScope offers an expansive network management and control portfolio that addresses the features, capacity and architectural requirements of organizations of all types and sizes. The common element being networking simplicity.

- **RUCKUS SmartZone:** SmartZone network controllers simplify network setup and management, enhance security, minimize troubleshooting and ease upgrades for networks built on RUCKUS switches and access points. Whether you're building complex multi-geo networks or delivering multi-tier managed networking services, SmartZone network controllers deliver the scale, flexibility and openness to support the most sophisticated deployment scenarios.
- **RUCKUS Cloud:** RUCKUS Cloud takes the complexity of deploying and managing a distributed network out. It enables faster response to organizational needs while also reducing IT overhead. RUCKUS Cloud eliminates the need to deploy on-premises controllers and management software, moving network management to the cloud. Your multi-site network can be centrally managed through a single pane of glass web-based UI and full-featured mobile app.
- **RUCKUS Unleashed:** Unleashed is a simple-to-setup, easy-to-run management solution in a package designed and priced for small businesses. With built-in controller functionality, there's no need to invest in a separate appliance for Wi-Fi control or in network management software. You can manage your entire network from your phone or web browser including all your APs and switches together.

With RUCKUS unified management solutions, organizations can proactively monitor the network and perform network-wide troubleshooting, generate traffic reports, and gain visibility into network activity from the wireless edge to the core.

RUCKUS ICX key solution areas

The RUCKUS® ICX® fixed form factor switch families offer high-performance and cost-effective solutions for campus and edge data center environments, including gigabit and multigigabit access solutions, 10/40/100 GbE campus core and aggregation, top-of-rack (ToR) server connectivity and leaf/spine topology in small to mid-sized enterprise datacenter.

Distributed chassis architecture for ultimate deployment flexibility

CommScope redefines the economics of enterprise networking by delivering a unique 10/40/100 GbE aggregation/core solution in a fixed form factor and new levels of performance, availability, and flexibility. It provides the capabilities of a chassis with the flexibility and cost effectiveness of a stackable switch. The RUCKUS ICX 7850 delivers wire speed, non-blocking performance across all ports to support latency-sensitive applications such as real-time voice/ video streaming and Virtual Desktop Infrastructure (VDI). Up to 12 RUCKUS ICX 7850 switches can be stacked together using up to eight full-duplex 100 Gbps standard QSFP28 stacking ports that provide an unprecedented maximum of 9.6 Tbps of aggregated stacking bandwidth with full redundancy, eliminating inter-switch bottlenecks.

Complete enterprise campus solution from access to core

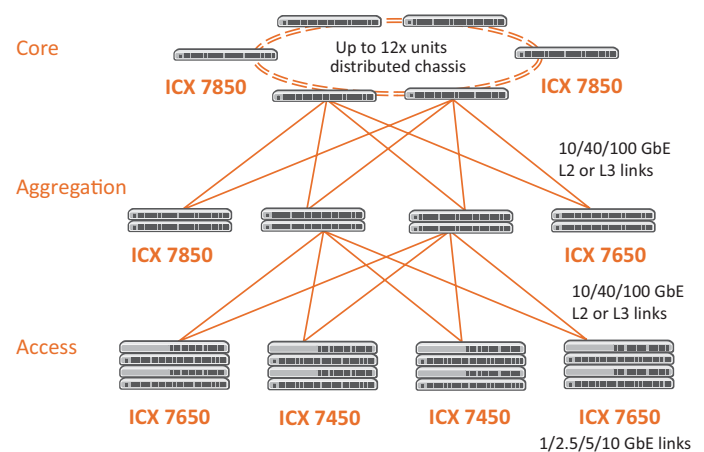

Figure 3: Traditional three-tier campus architecture.

CommScope offers a complete range of fixed form factor stackable switches to cover the connectivity needs of any size organization—from the access layer to the network core. These switches can be deployed in a traditional three-tier access/aggregation/core architecture with layer 2 or layer 3 links between the layers at 10, 40 and 100 Gbps link speed.

Core: The RUCKUS ICX 7850 provides the necessary advanced Layer 2 and Layer 3 features, high 10/40/100 GbE port density, and high-availability capabilities to handle the most demanding deployment scenarios. A stack of RUCKUS ICX 7850 switches interconnected with 100 GbE links makes a cost-effective, highly available campus core solution with active/standby control planes and hitless failover. Alternatively, a pair of ICX 7850 interconnected with multi-chassis trunking (MCT) delivers full redundancy at the core with active/active control planes.

Aggregation: CommScope offers a range of fiber switches that supports 1/10 GbE downlinks and 10/40/100 GbE uplinks ports with redundant power supplies and advanced L3 support, including the ICX 7450, ICX 7650, and ICX 7850.

Access: CommScope offers a broad range of gigabit and multigigabit switches with 1/25/5/10 GbE downlinks and 10/40/100 GbE uplinks, including the ICX 7150, ICX 7250, ICX 7450 and ICX 7650.

Collapsed campus aggregation/core

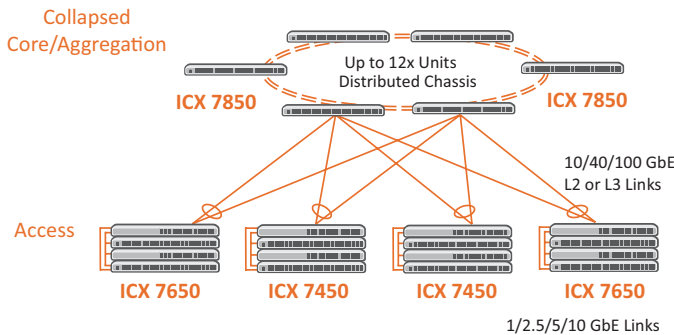

Figure 4: Two-tier campus network.

A simpler alternative to the traditional three-tier network architecture is a two-tier collapsed aggregation and core deployment. Thanks to CommScope industry-leading stacking density, it is possible to create a high-density and high-performance redundant aggregation/core layer that can scale significantly higher than traditional chassis deployments. This deployment model considerably simplifies management with the creation of LAGs (link aggregation groups) between stacked access switches and the aggregation/core layer, eliminating the need to deploy the spanning tree protocol between the access and the aggregation/core layer. The aggregation/core layers can also be managed as a single logical device—just like each access stack.

Unlike the traditional three-tier network design, with “big-box” chassis at the aggregation and core layers that offer limited deployment flexibility and future-proofing, CommScope distributed “multi-box” architecture can deliver much greater scalability and future-proofing with an easier “upgrade as you go” model. This type of architecture enables network architects to add capacity exactly where it is needed in the network, unlike a big-box chassis approach, with all ports located in the same closet.

Thanks to rapid technology evolution and innovative thinking, CommScope offers a stackable solution for campus aggregation and core that delivers higher performance and port density than a traditional chassis, while offering the same level of reliability and availability.

Distributed campus aggregation/core

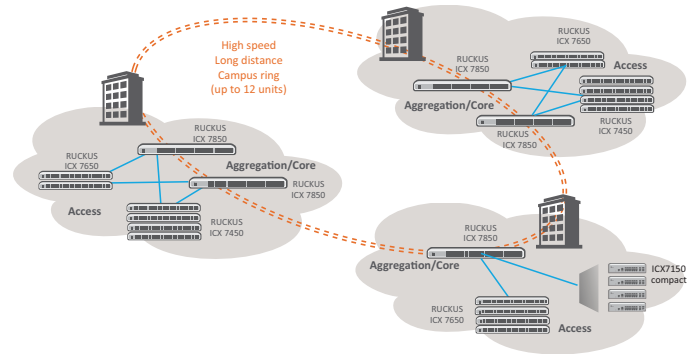

Figure 5: Distributed two-tier campus network.

With CommScope’s unique long-distance stacking capability, the collapsed aggregation/core layer can be distributed across an entire campus and across geographical areas. CommScope’s unique ability to leverage standard SFP and QSFP transceivers and fiber optics for stacking enables long-distance stacking with up to 10 km between stack switches. This extends single-point management across the entire campus for the core/aggregation switches.

Thanks to long-distance stacking technology, a ring of RUCKUS ICX 7850 switches interconnected with up to 8x 100 GbE stacking links and separated by up to 10 km can be used as a combined aggregation and core layer for a midsize campus.

Data center ToR server connectivity

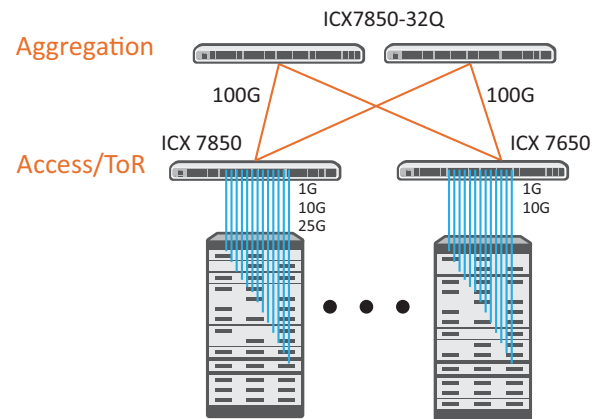

Figure 6: Data center top-of-the-rack connectivity.

RUCKUS ICX switches are designed to fit in server racks; they consume only one rack unit and support front-to-back or back-to-front airflow options, advanced L2 and L3 protocols and redundant power supplies and fans for maximum data center deployment flexibility and reliability.

To simplify cabling, the 1/10/25 GbE network interface cards (NICs) in the servers connect to the RUCKUS ICX downlink ports by using SFP/SFP+/SFP28 direct-attached copper cables. Servers with only 1 GbE-capable NICs can be connected to 10/25 GbE ICX 7850 using a 10 GbE port with a 1 GbE SFP transceiver. RUCKUS ICX ToR switches can connect to the data center aggregation/core switches with 10/40/100 GbE links using L2 LAGs or L3 protocols for maximum performance.

Cost-effective high-performance 100G spine-leaf data center connectivity

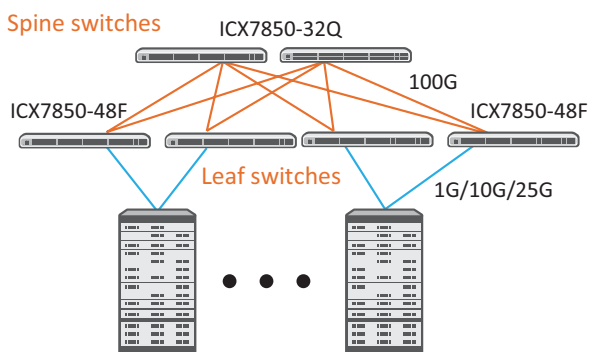

Figure 7: ICX 7850 spine-leaf solution.

Traditional three-tier network design in the data center is increasingly being replaced with spine-leaf design. The spine-leaf architecture is adaptable to the continuously changing needs of evolving data centers. In a spine-leaf architecture, any two servers must be the same number of hops away from each other to ensure the same predictable and consistent latency between any two devices connected to the network. To facilitate this, every leaf switch must be connected to every spine switch.

For organizations looking for high-performance 100/25 GbE spine-leaf data center connectivity, the RUCKUS ICX 7850 is an ideal solution with fully redundant hot-swappable power supplies and fans, front-to-back/back-to-front airflow options and support for advanced L3 protocols.

Spine: The ICX 7850-32Q offers a compact, cost-effective and high-performance spine switch. It connects to the data center core through 40/100 GbE ports, and it uses 100 GbE links to connect to ICX 7850-48F leaf switches at the edge of the network.

Leaf: The 7850 is ideal as a leaf switch offering 1/10/25 GbE downlinks to cover the whole spectrum of server connectivity options and can connect to spine switches at 100 GbE speed with up to eight uplinks.

Overview of RUCKUS ICX 7000 product family

	ACCESS				ACCESS/AGGREGATION		AGGREGATION/CORE	
	ICX 7150 Compact	ICX 7150	ICX 7150 Z-Series	ICX 7250	ICX 7450	ICX 7650	ICX 7750	ICX 7850

SWITCH CAPACITY								
Switching capacity (max)	120 Gbps	180 Gbps	304 Gbps	256 Gbps	336 Gbps	1.128 Tbps	2.56 Tbps	6.4 Tbps
1 GbE RJ45 ports	8 or 10 or 12 +2	24 or 48 +2	48	24 or 48	24 or 48	48	48	
1 GbE SFP ports	2	24	8	8	48	48	48	48
1/2.5 GbE RJ45 ports (max)	8		16					
1/2.5/5/10 GbE RJ45 ports (max)	2					24		
10 GbE SFP+ ports (max)	2	4	8	8	12	24+4	96 ²	128 ²
10 GbE RJ45 ports (max)					12		48	
25 GbE SFP28 ports (max)								48
40 GbE QSFP+ ports (max)					3	2	32	
100 GbE QSFP28 ports (max)						2		32
PoE Power-Budget (max)	240 W	740 W	1480 W	1480 W ¹	1496 W	1500 W		
Switches per stack (max)	12	12	12	12	12	12	12	12
Aggregated stack bandwidth	240 Gbps	480 Gbps	480 Gbps	480 Gbps	960 Gbps	2.4 Tbps	5.76 Tbps	9.6 Tbps

KEY FEATURES									
PoE / PoE+	●	●	●	●	●	●			
Stacking	●	●	●	●	●	●	●	●	
sFlow	●	●	●	●	●	●	●	●	
L3: Static-Routing / RIP/ OSPF	●	●	●	●	●	●	●	●	
OpenFlow	●	●	●	●	●	●	●	● ⁵	
EEE (energy-efficient Ethernet)		●	●	●	●	● ⁵			
Campus fabric	● ³	● ³	● ³	● ³	● ³	○ ⁴	○ ⁴	○ ^{4,5}	
Redundant power option			●	●	●	●	●	●	
Hot-swap PSUs & fans			●		●	●	●	●	
Multigig (IEEE 802.3bz)	●		●			●			
802.3bt ports (90W per port)	●		●		●	●			
L3: BGP					●	●	●	●	
L3: VRF				●	●	●	●	●	
MACsec					●	●		●	
IPsec VPN					●				
Reversible airflow option					●	●	●	●	
VXLAN							●	● ⁵	
MCT						●	●	●	
Unified network management options	<ul style="list-style-type: none"> • SmartZone • Cloud • Unleashed 	<ul style="list-style-type: none"> • SmartZone • Cloud • Unleashed 	<ul style="list-style-type: none"> • SmartZone • Cloud • Unleashed 	<ul style="list-style-type: none"> • SmartZone • Unleashed 	<ul style="list-style-type: none"> • SmartZone • Unleashed 	<ul style="list-style-type: none"> • SmartZone • Cloud • Unleashed 	<ul style="list-style-type: none"> • SmartZone • Unleashed 	<ul style="list-style-type: none"> • SmartZone • Cloud • Unleashed 	<ul style="list-style-type: none"> • SmartZone • Cloud • Unleashed

¹ With external power supply unit. ² With QSFP+ splitter cables. ●³ Fabric port extender mode. ○⁴ Fabric control bridge mode. ●⁵ Available in a future software release.

RUCKUS ICX 7150

The RUCKUS® ICX® 7150 series of stackable switches delivers the performance, flexibility, and scalability required for enterprise access deployment, raising the bar with non-blocking performance and up to 8x10 GbE ports for uplinks or stacking. It offers seamless interoperability with CommScope wireless products to deliver unified wired and wireless network access.

RUCKUS ICX 7150 switches

The standard RUCKUS ICX 7150 switches are available in 24- and 48-port 10/100/1000 Mbps models with four 1/10 GbE dual-purpose uplink/stacking ports. Switches are available with or without PoE+ power. Silent operation is available to use with in- or out-of-closet environments.

RUCKUS ICX 7150 Z-Series switches

The RUCKUS ICX 7150-48ZP 48-port switch adds higher performance, greater resiliency and increased PoE power. The switch offers multigigabit technology (IEEE 802.3bz) to match the highest performing 802.11ac Wave 2 wireless access points available, with dual redundant, hot-swappable power supplies and fans, and up to 8x10 GbE uplink/stacking ports.







The switch offers 16 multigigabit (100 Mbps/1 Gbps/2.5 Gbps) ports, each with power-over-HDBaseT (PoH) up to 90 watts, plus 32 10/100/1000 Mbps ports with PoE+. With a maximum PoE budget of 1480 watts, this switch delivers the power and performance to drive PoE+ power to all 48 ports.

RUCKUS ICX 7150 compact switches

The RUCKUS ICX 7150 compact switches come in 8-, 10-, and 12-ports models and feature a fanless design to operate silently in out-of-closet environments such as offices, classrooms, and retail spaces. They offer PoE on all ports. The 7150-C10ZP delivers up to 90 watts per port of PoE power and multigigabit Ethernet at 2.5/5 and 10 Gbps speeds. With 2x1/10 GbE uplink/stacking ports, the ICX 7150-C12 and C10ZP deliver high performance in a small package.

RUCKUS ICX 7150

These RUCKUS ICX 7150 models offer a single integrated power supply, one RJ45 Ethernet port for out-of-band network management, one USB Type-C port for console management, one RJ45 port for serial console management, and one USB port for storage.

	RUCKUS ICX 7150-24 switch <ul style="list-style-type: none"> • 24+2 x 10/100/1000 Mbps RJ45 ports • 4x 1/10 GbE uplink/stacking SFP/SFP+ ports
	RUCKUS ICX 7150-24P switch <ul style="list-style-type: none"> • 24+2 x 10/100/1000 Mbps RJ45 ports • 24 PoE+ ports, 370W PoE budget • 4x 1/10 GbE uplink/stacking SFP/SFP+ ports
	RUCKUS ICX 7150-48 switch <ul style="list-style-type: none"> • 48+2 x 10/100/1000 Mbps RJ45 ports • 4x 1/10 GbE uplink/stacking SFP/SFP+ ports
	RUCKUS ICX 7150-48P switch <ul style="list-style-type: none"> • 48+2 x 10/100/1000 Mbps RJ45 ports • 48 PoE+ ports, 370W PoE budget • 4x 1/10 GbE uplink/stacking SFP/SFP+ ports
	RUCKUS ICX 7150-48PF switch <ul style="list-style-type: none"> • 48+2 x 10/100/1000 Mbps RJ45 PoE+ ports • 48 PoE+ ports, 740W PoE budget • 4x 1/10 GbE uplink/stacking SFP/SFP+ ports
	RUCKUS ICX 7150-24F switch <ul style="list-style-type: none"> • 24x 100/1000 Mbps SFP ports • 2x 10/100/1000 Mbps uplink RJ45 ports • 4x 1/10 GbE uplink/stacking SFP/SFP+ ports



RUCKUS ICX 7150 Z-SERIES

The RUCKUS ICX 7150 Z-Series switch offers redundant hot-swappable load sharing power supplies, up to two hot-swappable fans, one RJ45 Ethernet port for out-of-band network management, one USB Type-C port for console management, one RJ45 port for serial console management, and one USB port for storage.

	RUCKUS ICX 7150-48ZP <ul style="list-style-type: none"> • 16x 100/1000 Mbps/2.5 Gbps RJ45 PoH ports • 32x 10/100/1000 Mbps RJ45 PoE+ ports • 1,480 W PoE budget (with two power supplies) • 8x 1/10 GbE uplink/stacking SFP/SFP+ ports
--	---

RUCKUS ICX 7150 COMPACT SWITCHES

The RUCKUS ICX 7150 compact switches offer a single integrated power supply, one RJ45 Ethernet port for out-of-band network management¹, one USB Type-C port for console management, one RJ45 port for serial console management¹, and one USB port for storage¹.

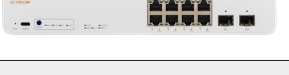
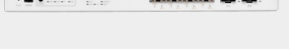
	RUCKUS ICX 7150-C10ZP compact switch <ul style="list-style-type: none"> • 10x RJ45 multigigabit ports, including 8x 2.5 GbE ports and 2x 2.5/5/10 GbE ports • 2x 1/10 GbE uplink/stacking SFP/SFP+ ports • 240W PoE budget. Delivers up to 90W per port on 4 PoH 802.3bt ready ports. Fanless.
	RUCKUS ICX 7150-C12P compact switch <ul style="list-style-type: none"> • 12+2 x 10/100/1000 Mbps RJ45 ports • 12 PoE+ ports, 124W PoE budget. Fanless. • 2x 1/10 GbE uplink/stacking SFP/SFP+ ports
	RUCKUS ICX 7150-C08P compact switch <ul style="list-style-type: none"> • 8x 10/100/1000 Mbps PoE+ RJ45 ports • 2x 1 GbE SFP uplink ports • 62W PoE power budget. Fanless
	RUCKUS ICX 7150-C08PT compact switch <ul style="list-style-type: none"> • 8x 10/100/1000 Mbps POE+ RJ45 ports • 2x 1 GbE SFP uplink ports • 62W PoE power budget. Fanless. • Extended temperature (-40C to 55C), IP30 rated

¹ Not supported on ICX 7150 eight-port models.

RUCKUS ICX 7250

The RUCKUS® ICX® 7250 switch series combines enterprise-class features, manageability and the flexibility, and “pay as you grow” scalability of a stackable solution. The switch delivers the performance required for enterprise gigabit Ethernet (GbE) access deployment. It raises the bar with up to 8×10 GbE ports for uplinks or stacking and market-leading stacking density with up to 12 switches (576×1 GbE) per stack. RUCKUS ICX 7250 switches also offer an external power supply for failover resiliency, as well as increased PoE/PoE+ port availability.





The RUCKUS ICX 7250 is easy to deploy, manage, and integrate into both new and existing networks. Organizations can buy only what they need today, and easily scale out as demand grows and new technologies emerge. Optimizing performance based on specific requirements is easy, with flexible licensing upgrades, allowing users to upgrade from 1 GbE to 10 GbE ports for uplink and stacking.

Premium performance

Designed for small to medium-size enterprises, branch offices, and distributed campuses, these scalable edge switches deliver enterprise-class functionality at an affordable price—without compromising performance and reliability. The RUCKUS ICX 7250 delivers wire-speed, non-blocking performance across all ports to support latency-sensitive applications such as real-time voice/video streaming and virtual desktop Infrastructure (VDI). The switch is available in 24- and 48-port 10/100/1000 Mbps models with 1 GbE uplink or 10 GbE dual-purpose uplink/stacking ports—with or without PoE and PoE+—to support wireless mobility and IP communications without the need for additional power outlets or power injectors.

RUCKUS ICX 7250 SWITCHES

Except as noted, all RUCKUS ICX 7250 switches offer eight uplink/stacking ports, a single integrated power supply and fan, one RJ45 network management port, one mini USB serial management port, and one USB storage port on the front panel.

	<p>RUCKUS ICX 7250-24</p> <ul style="list-style-type: none"> • 24×10/100/1000 Mbps RJ45 ports • 8×1 GbE uplink/stacking ports; upgradable to 10 GbE
	<p>RUCKUS ICX 7250-24P</p> <ul style="list-style-type: none"> • 24×10/100/1000 Mbps RJ45 PoE+ ports • 370 W PoE budget • 8×1 GbE uplink/stacking ports; upgradable to 10 GbE
	<p>RUCKUS ICX 7250-48</p> <ul style="list-style-type: none"> • 48×10/100/1000 Mbps RJ45 ports • 8×1 GbE uplink/stacking ports; upgradable to 10 GbE
	<p>RUCKUS ICX 7250-48P</p> <ul style="list-style-type: none"> • 48×10/100/1000 Mbps RJ45 PoE+ ports • 740 W PoE budget • 8×1 GbE uplink/stacking ports; upgradable to 10 GbE

RUCKUS ICX 7250 EXTERNAL POWER SUPPLY OPTIONS

The optional RUCKUS ICX-EPS4000 is an external power supply source to provide additional power. It can be used for system power redundancy and increased PoE/PoE+ power budget.

	<p>ICX-EPS4000-SHELF</p> <ul style="list-style-type: none"> • 1U EPS external chassis that can accept up to four individual power supplies <p>RPS17 power supply</p> <ul style="list-style-type: none"> • 920-watt AC power supply for EPS 4000 chassis
--	---

RUCKUS ICX 7450

The RUCKUS® ICX® 7450 switch series delivers the performance, flexibility, and scalability required for enterprise Gigabit Ethernet (GbE) access deployment. It offers market-leading stacking density with up to 12 switches (576x 1 GbE and 48x 1/10 GbE ports) per stack and combines chassis-level performance with “pay as you grow” scalability of a stackable solution. The mid-market stackable switch is one of the first in its class to offer 40 GbE uplinks, enabling enterprises to dramatically increase their network capacity while using their existing optical wire infrastructure. In addition, the RUCKUS ICX 7450 is the industry’s first stackable switching solution to leverage the advantages of site-to-site IPsec VPN security to ensure end-to-end data integrity without the need for dedicated encryption appliances.

The modular design of the switch provides three slots for scaling up to 12 1/10 GbE SFP/SFP+ ports, 12 10GBASE-T ports, or up to three 40 GbE QSFP+ ports for uplink or stacking. Organizations can initially deploy 1 GbE or 10 GbE uplink ports and easily upgrade to 40 GbE ports on demand with a new, high-speed module. As a result, RUCKUS ICX 7450 delivers high performance across all ports for flawless support of latency-sensitive applications.





System-level high-availability features—such as dual hot-swappable, load-sharing, and redundant power supplies, and hot-swappable fan trays—offer another level of availability for the campus wiring closet, all in a 1 RU form factor.

The switch is an ideal network solution for campus network 1 GbE or small aggregation deployment with 10 GbE or 40 GbE uplinks to the core. The switch is also suitable for a data center top-of-rack (ToR) solution, providing a mix of 1 GbE and 10 GbE server connectivity ports with 10 GbE or 40 GbE uplinks to the data center aggregation or core.

Deployed as a standalone switch, a stack, or a fabric network, organizations reap the benefits of a flexible platform and the assurance that their investments are protected.

RUCKUS ICX 7450 SWITCHES

The RUCKUS ICX 7450 is available in six different models, offering three modular slots for interchangeable uplink/stacking modules (one in the front, two in the back), dual power supply slots, dual fan trays, one RJ45 network management port, one mini USB serial management port, and one USB storage port on the front panel.

	RUCKUS ICX 7450-24 <ul style="list-style-type: none"> • 24x10/100/1000 Mbps RJ45 ports
	RUCKUS ICX 7450-24P <ul style="list-style-type: none"> • 24x10/100/1000 Mbps RJ45 PoE+ ports with eight pre-assigned ports supporting PoH (90 W)
	RUCKUS ICX 7450-48 <ul style="list-style-type: none"> • 48x10/100/1000 Mbps RJ45 ports
	RUCKUS ICX 7450-48P <ul style="list-style-type: none"> • 48x10/100/1000 Mbps RJ45 PoE+ ports with eight pre-assigned ports supporting PoH (90 W)
	RUCKUS ICX 7450-48F <ul style="list-style-type: none"> • 48x100/1000 Mbps SFP ports

RUCKUS ICX 7450 PORT AND SERVICE MODULE OPTIONS

Four different optional port modules are offered for RUCKUS ICX switches. An optional service module for IPsec VPN encryption is offered for the RUCKUS ICX 7450 Switch. Except as noted, these modules are interchangeable and can be installed in any of the three modular slots within RUCKUS ICX switches.

ICX7400-4X1GF module	Four-port 100 Mbps/1 GbE SFP
ICX7400-4X10GF module	Four-port 1/10 GbE SFP/SFP+ for uplink or stacking
ICX7400-4X10GC module	Four-port 1/10 GbE 10GBASE-T copper
ICX7400-1X40GQ module	One-port 40 GbE QSFP+ for uplink or stacking
ICX7400-SERVICE-MOD module	Service module for IPsec VPN encryption

RUCKUS ICX 7450 POWER SUPPLY OPTIONS

The RUCKUS ICX 7450 offers a selection of PoE/non-PoE and AC/DC power supply options with front-to-back or back-to-front airflow cooling options. The DC power supply can be installed in either PoE or non-PoE switches.

RPS15 power supply	Non-PoE 250 W AC offered with back-to-front or front-to-back airflow models
RPS16 power supply	PoE 1,000 W AC offered with back-to-front or front-to-back airflow models
RPS16DC power supply	PoE 510 W DC offered with back-to-front or front-to-back airflow models

RUCKUS ICX 7650

The RUCKUS® ICX® 7650 switch series is designed to meet the new challenges of the multigigabit wireless era. It delivers non-blocking performance, high availability, and scalability with multigigabit Ethernet access, high PoE output as well as 10 gigabit Ethernet aggregation and 40G/100G uplink options.

Gigabit and multigigabit Access





The RUCKUS® ICX® 7650 stackable access switches come in gigabit and multigigabit versions. Both come standard with 40G and 100G ports for stacking. The gigabit model offers 48x 10/100/1000 Mbps ports with 40G/100G uplinks for future-ready next-generation wireless deployment. Both switches deliver non-blocking performance and offer PoE+, 802.3bt with up to 1,500 watts of PoE budget with two hot-swappable load-sharing power supplies. The switches are targeted at demanding enterprise customers who need a high-performance, highly reliable access switch at the edge of a campus network or as top-of-the-rack switch in the data center.

1 GbE / 10 GbE aggregation

The stackable ICX 7650 aggregation switch comes standard with 40 GbE and 100 GbE ports for stacking and/or uplinks and dual hot-swap power supplies for maximum reliability. The switch offers 24x 1/10 GbE SFP+ ports with legacy OM1/OM2 fiber support, and 24x GbE ports. It is targeted at customers looking for a cost-effective 10 GbE aggregation solution for small to midsize campus or data center networks that delivers enterprise features with L2/L3 capabilities, high availability and non-blocking performance and combines chassis-level capability with the “pay as you grow” scalability of a stackable solution. This mid-market 1/10G aggregation switch is the first in its class to offer 100 GbE uplinks, enabling organizations to dramatically increase their network capacity to deploy high-performance wireless access and run next-generation applications.

RUCKUS ICX 7650

All RUCKUS ICX 7650 models offer one modular slot in the front for interchangeable uplink modules, dual power supply slots, dual fan tray slots in the back, one RJ45 Ethernet port for out-of-band network management, one USB Type-C port for console management, one RJ45 port for serial console management, and one USB port for external file storage.

	<p>RUCKUS ICX 7650-48P</p> <ul style="list-style-type: none"> • 48x 10/100/1000 Mbps RJ45 ports with 40 supporting PoE+ and eight supporting PoE+, UPoE and PoH • One slot for 2x40G or 4x10G front-facing module • Up to 1500 W PoE budget
	<p>RUCKUS ICX 7650-48ZP</p> <ul style="list-style-type: none"> • 24x 1/10/1000 Mbps RJ45 PoE+ ports • 24x 100/1000 Mbps 2.5/5/10 Gbps RJ45 PoE+/PoH/UPoE ports • One slot for 1x 100G or 2x40G or 4x10G • Up to 1500 W PoE budget
	<p>RUCKUS ICX 7650-48F</p> <ul style="list-style-type: none"> • 24x 100/1000 Mbps SFP ports • 24x 1000 Mbps / 10 Gbps SFP+ ports • One slot for 1x 100G or 2x40G or 4x10G front-facing module
	<p>RUCKUS ICX 7650 rear view (all models)</p> <p>The four-rear facing QSFP ports can be configured as follows:</p> <ul style="list-style-type: none"> • 4x 40G QSFP+ stacking / 2x 40G QSFP+ uplink ports or 2x 100G QSFP28 stacking/uplink ports <p>Note: Front-facing optional module only enabled when rear ports are used for stacking. ICX 7650-48P only supports 2x40G rear-facing uplink ports.</p>

RUCKUS ICX 7650 PORT AND SERVICE MODULE OPTIONS

Three optional port modules are offered for the RUCKUS ICX 7650 switches. The ICX7650-1X100GQ module is not available for the ICX 7650-48P switch.

ICX7650-1X100GQ module	1x 40/100GE QSFP28 uplink port
ICX7650-2X40GQ module	2x 40GE QSFP+ uplink ports
ICX7650-4X10GF module	4x 10GE SFP+ uplink ports

RUCKUS ICX 7650 POWER SUPPLY OPTIONS

The Ruckus ICX 7650 offers a selection of PoE/non-PoE power supply options with front-to-back or back-to-front airflow cooling options.

RPS15 power supply	Non-PoE 250 W AC offered with back-to-front or front-to-back airflow models
RPS16 power supply	PoE 1,000 W AC offered with back-to-front or front-to-back airflow models
RPS16DC power supply	PoE 510 W DC offered with back-to-front or front-to-back airflow models

RUCKUS ICX 7750

The RUCKUS® ICX® 7750 switch series delivers industry-leading 10/40 GbE port density, advanced high-availability capabilities, and flexible stacking architecture, making it the most robust RUCKUS aggregation and core distributed chassis switch offering for enterprise LANs. In addition to rich Layer 3 features, the RUCKUS ICX 7750 scales to 12-unit distributed-chassis stacking and serves as the control bidge (master brain) for RUCKUS campus fabric technology.

The RUCKUS ICX 7750 switch is a 1U high-performance solution that meets the needs of business-sensitive campus deployments and classic data center environments. With a low-latency, cut-through, non-blocking architecture, the RUCKUS ICX 7750 provides a cost-effective, robust solution for the most demanding deployments.



Leading-edge design flexibility and reliability

The RUCKUS ICX 7750 switch provides the capabilities of a chassis with the flexibility and cost effectiveness of a stackable switch. RUCKUS ICX 7750 is available in three models: the RUCKUS ICX 7750-48F, 7750-48C, and 7750-26Q. The RUCKUS ICX 7750-48F and 7750-48C both offer 48 10 GbE ports (SFP+ and 10GBASE-T, respectively) and up to 12 40 GbE ports (six optional). The RUCKUS ICX 7750-26Q offers up to 32 40 GbE QSFP+ ports (six optional). All models support stacking, which allows organizations to buy only the ports they need now and expand later by adding switches to the stack where and when they are needed. This eliminates the need for a forklift upgrade and helps avoid provisioning an underutilized, centralized chassis.

Up to 12 RUCKUS ICX 7750 switches can be stacked together using up to 12 full-duplex 40 Gbps standard QSFP+ stacking ports that provide an unprecedented maximum of 5.76 Tbps of aggregated stacking bandwidth with full redundancy, eliminating inter-switch bottlenecks.

RUCKUS ICX 7750 SWITCHES

All RUCKUS ICX 7750 switches offer two slots for load-sharing, redundant power supplies, four fan slots, one RJ45 network management port, one mini USB serial management port, and one USB storage port.

	RUCKUS ICX 7750-26Q <ul style="list-style-type: none"> • 26x40 GbE QSFP+ ports
	RUCKUS ICX 7750-48F <ul style="list-style-type: none"> • 48x1/10 GbE SFP+ ports and 6x40 GbE QSFP ports
	RUCKUS ICX 7750-48C <ul style="list-style-type: none"> • 48x1/10 GbE RJ45 10GBASE-T ports and 6x40 GbE QSFP ports

RUCKUS ICX 7750 PORT OPTIONS

All RUCKUS ICX 7750 switches offer one modular interface slot in the back of the unit for additional ports.

ICX7750-6Q module	6x40 GbE QSFP+ module
--------------------------	-----------------------

RUCKUS ICX 7750 POWER SUPPLY OPTIONS

The RUCKUS ICX 7750 offers a selection of AC/DC power supply options with front-to-back or back-to-front airflow cooling options.

RPS9 power supply	500 W AC power supply
RPS9DC power supply	500 W DC power supply

RUCKUS ICX 7850

The RUCKUS® ICX® 7850 switch series is a high-performance stackable core switch for next-generation 100G campus. It delivers non-blocking line-rate performance on all ports concurrently, with a switching capacity up to 6.4 Tbps. The ICX 7850 supports the next-generation Ethernet speeds with 10/25 gigabit Ethernet at the aggregation and 40/100 gigabit Ethernet at the core to meet high-volume traffic driving from the edge into the core. It also supports a rich array of routing protocols and delivers a range of high-availability hardware and software features.

10/25 GbE aggregation



The RUCKUS® ICX® 7850 stackable aggregation switches come in 1/10 GbE and 1/10/25 GbE models. Both come standard with eight-ports of 40/100 GbE for stacking or uplinks. The 1/10 GbE model offers 48x 1/10 GbE ports with MACsec and LRM; the 1/10/25 GbE model offers 48x 1/10/25 GbE ports and 8x 40/100 GbE ports for uplinks or stacking. The switches are targeted at demanding enterprise customers who need a high-performance, highly reliable aggregation/core switch or as top-of-the-rack switches in the data center.

40/100 GbE aggregation/core

The ICX 7850-32Q stackable aggregation/core switch comes standard with 32 40/100 GbE ports, and up to eight of these ports can be used for stacking. The QSFP28 ports are capable of native 40 GbE or 100 GbE Ethernet, or may be broken out to 4x10 Gbps or 4x25 Gbps links to give up to 128 10/25 GbE ports for server aggregation in a data center, or switch aggregation in the campus.

RUCKUS ICX 7850

All RUCKUS ICX 7850 models offer dual power supply slots, five or six fan tray slots in the back, one RJ45 Ethernet port for out-of-band network management, one USB Type-C port for console management, one RJ45 port for serial console management, and one USB Type A port for external file storage.

	<p>RUCKUS ICX 7850-32Q</p> <ul style="list-style-type: none"> • 32x 40/100 GbE QSFP28 ports can be split into 128x 10/25 GbE ports with breakout cables • 2x hot-swappable load sharing power supplies and 6x hot-swappable fan assemblies
	<p>RUCKUS ICX 7850-48F</p> <ul style="list-style-type: none"> • 48x 1/10 GbE SFP+ ports with 128/256 bit MACsec and LRM support • 8x 40/100 Gbps QSFP28 ports can be split into 32x 10/25 GbE ports with breakout cables • 2x hot-swappable load sharing power supplies and 6x hot-swappable fan assemblies
	<p>RUCKUS ICX 7850-48F</p> <ul style="list-style-type: none"> • 48x 1/10/25 GbE SFP+ ports • 8x 40/100 Gbps QSFP28 ports can be split into 32x 10/25 GbE ports with breakout cables • 2x hot-swappable load sharing power supplies and 6x hot-swappable fan assemblies

RUCKUS ICX 7850 POWER SUPPLY OPTIONS

The RUCKUS ICX 7850 offers a selection of AC/DC power supply options with front-to-back or back-to-front airflow cooling options.

<p>RPS19</p>	<p>650W AC power supply offered with back-to-front or front-to-back airflow options</p>
<p>RPS19DC</p>	<p>650W DC power supply offered with back-to-front or front-to-back airflow options</p>

Warranty

RUCKUS ICX switches are covered by the RUCKUS Assurance® Limited Lifetime Warranty. For details, visit www.ruckuswireless.com/warranty.

Technical support

RUCKUS ICX switches come with 90 days of free technical support² from the RUCKUS Technical Assistance Center (TAC). For continued access to the TAC past the initial 90 days, customers must purchase a Technical Support contract. With technical support, users gain peace of mind while freeing up IT budget and resources to grow their businesses. For details, visit www.support.ruckuswireless.com/programs.

CommScope Global Services

CommScope Global Services has the expertise to help organizations build scalable, efficient cloud infrastructures. Leveraging two decades of expertise in networking to deliver world-class professional services, technical support, network monitoring services, and education, enabling organizations to maximize their investments, accelerate new technology deployments, and optimize the performance of networking infrastructures.

Notice: This document is for informational purposes only and does not set forth any warranty, expressed or implied, concerning any equipment, equipment feature, or service offered (or to be offered) by CommScope. CommScope reserves the right to make changes to this document at any time, without notice, and assumes no responsibility for its use. This informational document describes features that may not be currently available. Contact a CommScope sales office for information on feature and product availability. Export of technical data contained in this document may require an export license from the United States government.

² Check individual product data sheet for applicability.

COMMSCOPE®

commscope.com

Visit our website or contact your local CommScope representative for more information.

© 2020 CommScope, Inc. All rights reserved.

Unless otherwise noted, all trademarks identified by © or ™ are registered trademarks or trademarks, respectively, of CommScope, Inc. This document is for planning purposes only and is not intended to modify or supplement any specifications or warranties relating to CommScope products or services. CommScope is committed to the highest standards of business integrity and environmental sustainability, with a number of CommScope's facilities across the globe certified in accordance with international standards, including ISO 9001, TL 9000, and ISO 14001. Further information regarding CommScope's commitment can be found at www.commscope.com/About-Us/Corporate-Responsibility-and-Sustainability.

PA-113928.2-EN (04/20)